

381 Remote Display True-rms Clamp Meter

Users Manual

LIMITED WARRANTY AND LIMITATION OF LIABILITY

Each Fluke product is warranted to be free from defects in material and workmanship under normal use and service. The warranty period is 3 years and begins on the date of shipment. Parts, product repairs, and services are warranted for 90 days. This warranty extends only to the original buyer or end-user customer of a Fluke authorized reseller, and does not apply to fuses, disposable batteries, or to any product which, in Fluke's opinion, has been misused, altered, neglected, contaminated, or damaged by accident or abnormal conditions of operation or handling. Fluke warrants that software will operate substantially in accordance with its functional specifications for 90 days and that it has been properly recorded on non-defective media. Fluke does not warrant that software will be error free or operate without interruption.

Fluke authorized resellers shall extend this warranty on new and unused products to end-user customers only but have no authority to extend a greater or different warranty on behalf of Fluke. Warranty support is available only if product is purchased through a Fluke authorized sales outlet or Buyer has paid the applicable international price. Fluke reserves the right to invoice Buyer for importation costs of repair/replacement parts when product purchased in one country is submitted for repair in another country.

Fluke's warranty obligation is limited, at Fluke's option, to refund of the purchase price, free of charge repair, or replacement of a defective product which is returned to a Fluke authorized service center within the warranty period.

To obtain warranty service, contact your nearest Fluke authorized service center to obtain return authorization information, then send the product to that service center, with a description of the difficulty, postage and insurance prepaid (FOB Destination). Fluke assumes no risk for damage in transit. Following warranty repair, the product will be returned to Buyer, transportation prepaid (FOB Destination). If Fluke determines that failure was caused by neglect, misuse, contamination, alteration, accident, or abnormal condition of operation or handling, including overvoltage failures caused by use outside the product's specified rating, or normal wear and tear of mechanical components, Fluke will provide an estimate of repair costs and obtain authorization before commencing the work. Following repair, the product will be returned to the Buyer transportation prepaid and the Buyer will be billed for the repair and return transportation charges (FOB Shipping Point).

THIS WARRANTY IS BUYER'S SOLE AND EXCLUSIVE REMEDY AND IS IN LIEU OF ALL OTHER WARRANTIES, EXPRESS OR IMPLIED, INCLUDING BUT NOT LIMITED TO ANY IMPLIED WARRANTY OF MERCHANTABILITY OR FITNESS FOR A PARTICULAR PURPOSE. FLUKE SHALL NOT BE LIABLE FOR ANY SPECIAL, INDIRECT, INCIDENTAL OR CONSEQUENTIAL DAMAGES OR LOSSES, INCLUDING LOSS OF DATA, ARISING FROM ANY CAUSE OR THEORY.

Since some countries or states do not allow limitation of the term of an implied warranty, or exclusion or limitation of incidental or consequential damages, the limitations and exclusions of this warranty may not apply to every buyer. If any provision of this Warranty is held invalid or unenforceable by a court or other decision-maker of competent jurisdiction, such holding will not affect the validity or enforceability of any other provision.

Fluke Corporation
P.O. Box 9090
Everett, WA 98206-9090
U.S.A.

Fluke Europe B.V.
P.O. Box 1186
5602 BD Eindhoven
The Netherlands

Table of Contents

Title	Page
Introduction.....	1
Contact Fluke	1
Safety Information	1
Radio Frequency Data.....	1
Features.....	3
Remote Display	3
Hazardous Voltage Indicator	4
Flexible Current Probe	4
Auto Power Off.....	4
Backlight.....	5
Display Hold	5
MIN MAX AVG	5
DC Current Zero	5
Inrush	5
Low Battery Indicators	5
Display	7
Measurements	8
AC and DC Current (Jaw)	8
AC Current (Flexible Current Probe)	9
AC and DC Voltage.....	11
Resistance/Continuity.....	11
Inrush Current Measurement (Jaw and Flexible Current Probe).....	12
Frequency Measurement (Jaw and Flexible Current Probe).....	12
Maintenance	13
Cleaning the Meter and Flexible Current Probe	13
Battery Replacement.....	13
Product Disposal.....	14
User-Replaceable Parts.....	14
Specifications	15
Electrical Specifications.....	15
Mechanical Specifications	16

Introduction

The Fluke 381 Remote Display True-rms Clamp Meter (the Product or Meter) is a handheld, battery-operated Clamp Meter (the Meter) that has a remote-display module and detachable iFlex (Flexible Current Probe). The Remote Display can be removed from the Meter body and read away from the measurement source. This lets the display be easily read in difficult-measurement situations such as a hazardous environments, or very tight spaces. The Flexible Current Probe makes it possible to measure higher current (up to 2500 A ac) and larger cables that traditional jawed meters cannot measure.

Contact Fluke

Fluke Corporation operates worldwide. For local contact information, go to our website: www.fluke.com.

To register your product, or to view, print, or download the latest manual or manual supplement, go to our website.

+1-425-446-5500 fluke-info@fluke.com

Safety Information

General Safety Information is in the printed Safety Information document that ships with the Product and at www.fluke.com. More specific safety information is listed where applicable.

A **Warning** identifies hazardous conditions and procedures that are dangerous to the user. A **Caution** identifies conditions and procedures that can cause damage to the Product or the equipment under test.

Radio Frequency Data

Note

Changes or modifications to the wireless 2.4 GHz radio not expressly approved by Fluke Corporation could void the user's authority to operate the equipment.

This device complies with Part 15 of the FCC Rules. Operation is subject to the two conditions that follow:

1. This device cannot cause interference.
2. This device must accept any interference, including interference that can cause undesired operation of the device.

Class B digital device: A digital device that is marketed for operation in a residential environment not withstanding use in commercial, business and industrial environments. Examples of such devices include, but are not limited to, personal computers, calculators, and equivalent electronic devices that are marketed for operation by the general public.

The Meter was tested and found to comply with the limits for a Class B digital device, pursuant to Part 15 of the FCC Rules. These limits are designed to provide reasonable protection against harmful interference in a residential installation. This equipment generates, uses, and can radiate radio frequency energy and, if not installed and used in accordance with the instructions, can cause harmful interference to radio communications. However, there is no guarantee that interference will not occur in a particular installation. If this equipment does cause harmful interference to radio or television reception, which can be determined by turning the equipment off and on, the user is encouraged to try to correct the interference by one or more of the measures that follow:

- Reorient or relocate the receiving antenna.
- Increase the separation between the equipment and receiver.
- Consult the dealer or an experienced radio/TV technician for help.

The term "IC:" before the radio certification number only signifies the device meets Industry's Canada technical specifications.

This device complies with the following items of NCC related rules:

Article 12

Without permission granted by the NCC, any company, enterprise, or user is not allowed to change frequency, enhance transmitting power or alter original characteristics as well as performance to approved low-power radio frequency devices.

Article 14

The low-power radio frequency devices shall not influence aircraft security and interfere with legal communications. If found, the user shall cease operating immediately until no interference is achieved. The said legal communications means radio communications is operated in compliance with the Telecommunications Act.

The low-power radio frequency devices must be susceptible with the interference from legal communication or ISM radio wave radiated devices.

Features

The following sections explain the Meter features in detail.

Remote Display

The Meter uses low-power 802.15.4 wireless technology to let the display module operate in a different location than the Meter base. Although there is control of some Meter functions (Hold, MIN MAX AVG, and Backlight), complete remote control of the Meter is not available through the display module.

The wireless radio signal does not hinder Meter measurements. Usually, the radio signal is off when the display module is docked to the Meter base. It is possible for the radio signal to be on when the display module is docked and the Rotary Function Switch is set to OFF. To make sure that the radio signal is off, remove the batteries from the Meter base and display module.

The display module is synchronized with a Meter base when it is docked on the Meter base and turned on. Different display modules can be synchronized with a Meter base but, only one display module can be synchronized to a Meter base at the same time.

The Meter base and display can be a maximum of 10 meters from each other before the radio signal connection is broken. This distance can change with the obstacles between the Meter base and display. There is a radio connection when  shows in the display.

To detach the display from the Meter base, see [Figure 1](#).

Figure 1. Remote Display

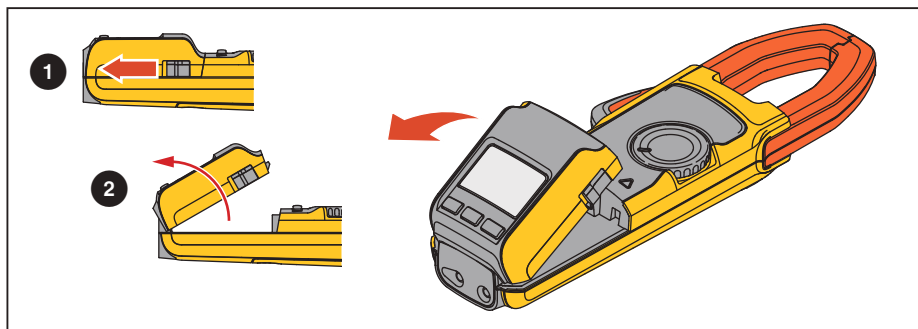

The wireless radio signal does not hinder Meter measurements. Usually, the radio signal is off when the Display Module is docked to the Meter base.

To verify the Meter firmware version, turn off the Meter and simultaneously push **HOLD** and turn the Rotary Function Switch to \bar{V} .

Meter with Firmware Version <0.9

It is possible for the radio signal to be on when the Display Module is docked and the Rotary Function Switch is set to OFF. To make sure that the radio signal is off, remove the batteries from the Meter base and Display Module.

Meter with Firmware Version ≥ 0.9

None

Hazardous Voltage Indicator

During a voltage measurement, the Meter alerts you to the presence of a potentially hazardous voltage. When the Meter senses a voltage ± 30 V or a voltage overload (OL), ⚡ is shown on the display and the red high-voltage LED (⚡) on the Meter base illuminates to tell you a hazardous voltage is at the Meter input.

Flexible Current Probe

Warning

To prevent electrical shock, do not apply or remove from live hazardous conductors.

The high-performance AC Flexible Current Probe utilizes the Rogowski principle and is used for accurate, non-intrusive measurement of sinusoidal, pulsed, and other complex waveforms. The flexible and lightweight measuring head allows quick and easy installation in hard-to-reach areas and works well with large conductors.

For more information about the Flexible Current Probe, see [AC Current \(Flexible Current Probe\)](#).

Auto Power Off

The Meter powers off if there is no button push or Rotary Function Switch operation for 20 minutes. Auto Power Off is disabled during Min Max Avg function use. To disable the Auto Power Off, hold down  while you turn on the Meter.

Units with Firmware Version <0.9



If the Meter powers off, turn OFF the Rotary Function Switch and then back on again.

Units with Firmware Version ≥ 0.9



If the Meter powers off:

1. Dock the Display Module to the Meter base.
2. Turn the Rotary Function Switch to OFF.
3. Turn the Rotary Function Switch to any function to turn on the Meter.

Backlight

Push  to toggle the Backlight on and off. The Backlight automatically goes off after 2 minutes. To disable the Backlight Auto Off feature, hold down  while turning on the Meter.

Display Hold

To capture and hold the present display reading, push  while taking a reading. Push  again to return to the live reading.

MIN MAX AVG

Min Max Avg mode can capture the minimum, maximum, and average readings of a given output signal over an extended time.

Push  to enter Min Max Avg mode, push again to toggle between min and max readings.

Push a third time to display the average reading. To exit Min Max Avg mode, push and hold  for 2 seconds. When Min Max Avg mode is active, the Auto Power Off feature is disabled.

DC Current Zero

Push  to remove any dc offset that could affect the accuracy of dc readings.

Inrush

Inrush Current is surge current that occurs when an electrical device is first powered on. The Meter can capture this surge current reading. Current spikes from motor drives are one example of such an event. The Inrush function takes approximately 400 samples over a 100 ms period and calculates the starting current envelope.

Low Battery Indicators





The Meter uses two low battery symbols: **meter ** and **remote **. When **meter ** appears, the batteries in the Meter base should be changed. Low batteries on the Meter base will affect the readings. When **remote ** is displayed, the batteries for the removable display should be changed. Measurements are not affected by low batteries in the display.

Table 1. Meter Features



Item	Description
1	Current Sensing Jaw
2	Tactile Barrier
3	Rotary Function Switch, see Table 2
4	Hazardous-voltage indicator
5	Display release button
6	Display, see Table 3
7	Backlight button: turns the Backlight on and off. The Backlight stays on for 2 minutes when there is no button or switch interaction and then shuts off.
8	Hold button: freezes the display reading and releases the reading when pushed a second time.
9	Min Max button: when first pushed, the Meter shows maximum input. With subsequent pushes, the minimum and the average inputs are shown. Hold  for 2 seconds to exit min max mode. This function works in current, voltage, and frequency modes.
10	Zero/Shift button: removes dc offset from dc current measurements. Also used to shift and corresponds to the yellow items on the Rotary Function Switch.
11	Inrush button: push to enter inrush mode. Push a second time to exit inrush mode. Integration time is 100 ms.
12	Jaw release
13	Alignment marks: to meet accuracy specifications, the conductor must be aligned with these marks.
14	Common terminal
15	Volt/Ohm input terminal
16	Flexible Current Probe input terminal

Table 2. Rotary Function Switch

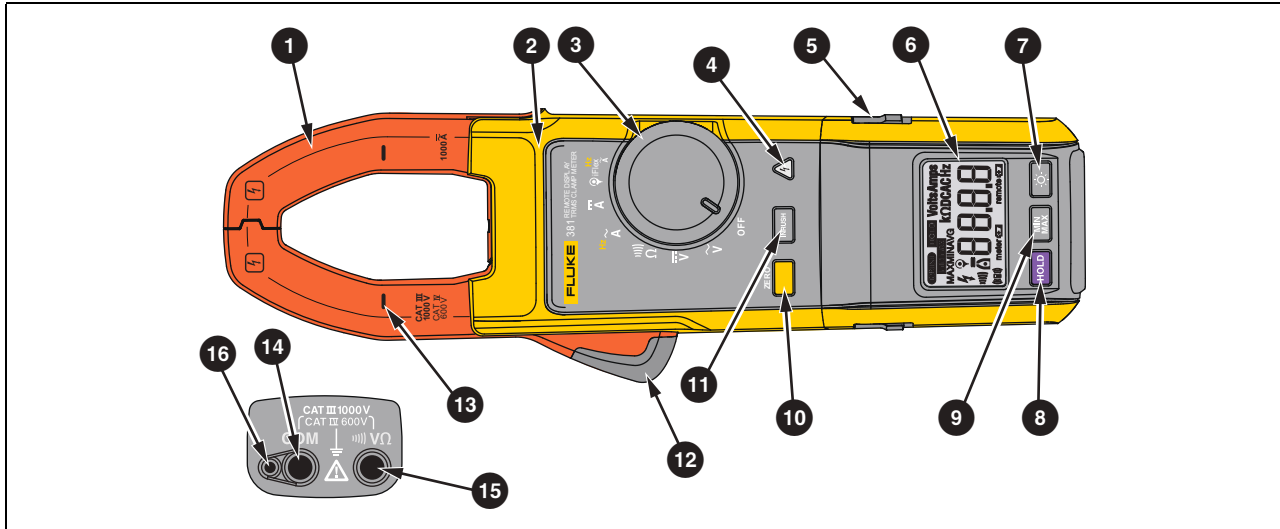
Switch Position	Function
OFF	Meter is powered down
\tilde{V}	AC voltage
\overline{V}	DC voltage
Ω	Resistance and continuity
$\text{Hz} \sim$ A	AC current. Push <input type="checkbox"/> ZERO to shift to frequency.
\overline{A}	DC current
Hz iFlex A	AC current and frequency measurement using the Flexible Current Probe. Push <input type="checkbox"/> ZERO to shift to frequency.

Display

To view all segments on the display at once, push HOLD while turning the Meter on. See [Table 3](#).

Table 3. Display

Item	Description	Item	Description
1	Inrush is active	8	Meter base low-battery
2	Hold is active	9	Measurement is taken at the Jaw.
3	Volts	10	RF signal is being sent to remote display
4	Amps	11	Continuity
5	Ohms, DC, AC, Hz	12	Hazardous voltage is present.
6	Main display	13	Measurement is taken at the Flexible Current Probe.
7	Remote display low-battery	14	Min, Max, or Avg reading is shown.
		15	Min Max mode is active.

Measurements

Note

Prior to first use, remove the battery isolator (small piece of plastic between the batteries and battery contacts).

AC and DC Current (Jaw)

Warning

To prevent electric shock or personal injury:

- **When making current measurements, disconnect the test leads from the Meter.**
- **Keep fingers behind Tactile Barrier. See [Table 1](#).**

Note

When measuring current, center the conductor in the Jaw using the alignment marks on the Jaw.

Before taking dc measurements, push  to ensure correct readings. Zeroing the Meter removes dc offset from the reading. The Zero function works only in the dc current measurement Rotary Function Switch position.

Note

Before zeroing the Meter, make sure the Jaws are closed and there is no conductor inside the Jaw.

To measure ac or dc current:

1. Turn the Rotary Function Switch to the proper function. You should see  on the display, indicating that the measurement is coming from the Jaw.

Note

When the measured current is <0.5 A, the center dot in the display icon  will flash on and off. With current >0.5 A, the center dot will be steady.

2. If measuring dc, wait for the display to stabilize and then push  to zero the Meter.
3. Open the Jaw by pressing the Jaw Release and insert the conductor into the Jaw.
4. Close the Jaw and center the conductor using the alignment marks.

5. View the reading on the display. [Figure 2](#).

Note

Current flowing in opposite directions cancels each other. If current is moving in opposite directions, place one conductor into the clamp at a time. See [Figure 2](#).

Figure 2. Current Measurement with Jaw

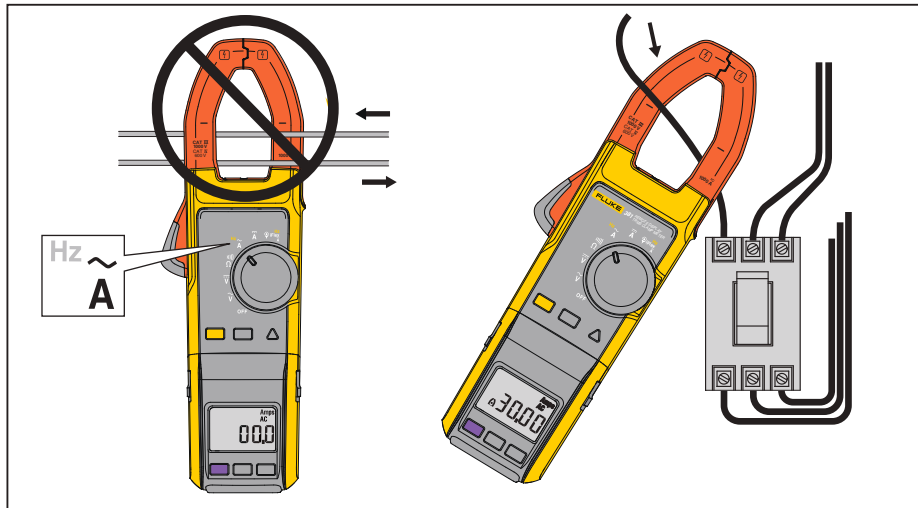

AC Current (Flexible Current Probe)

⚠⚠ Warning

To prevent possible electrical shock or personal injury, do not apply the Flexible Current Probe around or remove from HAZARDOUS LIVE conductors. Take special care during fitting and removal of the Flexible Current Probe. De-energize the installation under test or wear suitable protective clothing.

To use the Flexible Current Probe, follow these instructions:

1. Connect the Flexible Current Probe to the Meter. See [Figure 3](#).
2. Connect the flexible part of the Flexible Current Probe around the conductor. If opening the end of the Flexible Current Probe to make the connection, make sure that you close and latch it. See the detail in [Figure 3](#). You should be able to hear and feel the Flexible Current Probe lock snap into place.

Note

When measuring current, center the conductor in the Flexible Current Probe. If possible, avoid taking measurements close to other current-carrying conductors.

3. Keep the probe coupling more than 2.5 cm (1 inch) away from the conductor.
4. Turn the Rotary Function Switch to $\text{iFlex}_{\text{A}}^{\text{Hz}}$. When the Rotary Function Switch is in the correct position, $\text{iFlex}_{\text{A}}^{\text{Hz}}$ shows on the display to indicate that the readings are from the Flexible Current Probe.

Note

When the measured current is $<0.5 \text{ A}$, the center dot in the display icon ($\text{iFlex}_{\text{A}}^{\text{Hz}}$) will flash on and off. With current $>0.5 \text{ A}$, the center dot will be steady.

5. Observe the current value on the Meter display.

If the Flexible Current Probe does not perform as expected:

- Inspect the coupling system to make sure that it is connected and closed correctly or for any damage. If any foreign material is present, the coupling system will not close properly.
- Inspect the cable between the Flexible Current Probe and the Meter for any damage.
- Check that the Rotary Function Switch of the Meter is in the correct position ($\text{iFlex}_{\text{A}}^{\text{Hz}}$).

Figure 3. Flexible Current Probe Connection

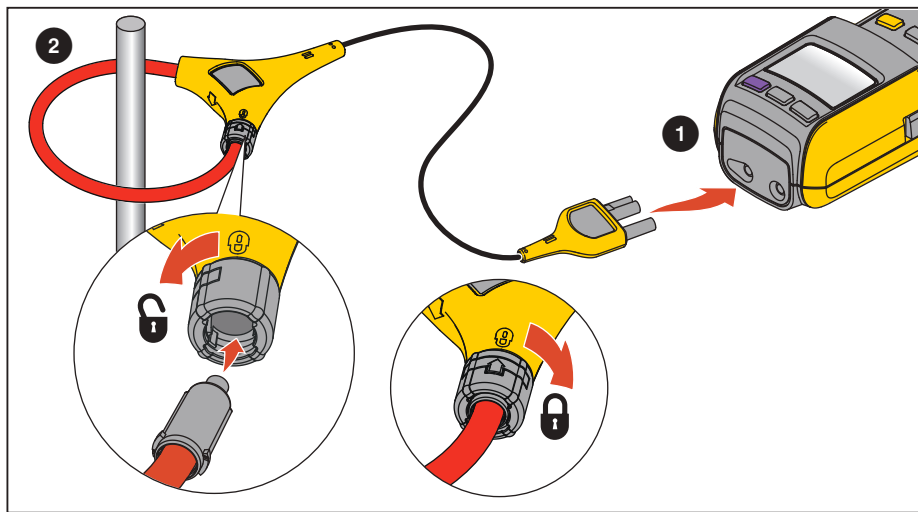

AC and DC Voltage

To measure ac or dc voltage:

1. Turn the Rotary Function Switch to the proper voltage function (\tilde{V} or \bar{V}).
2. Connect the black test lead to the **COM** terminal and the red test lead to the $\text{V}\Omega$ terminal. See [Figure 4](#).
3. Measure the voltage by touching the probes to the desired test points of the circuit. View the reading on the display.

Figure 4. Measurement with Test Leads (AC Voltage Shown)

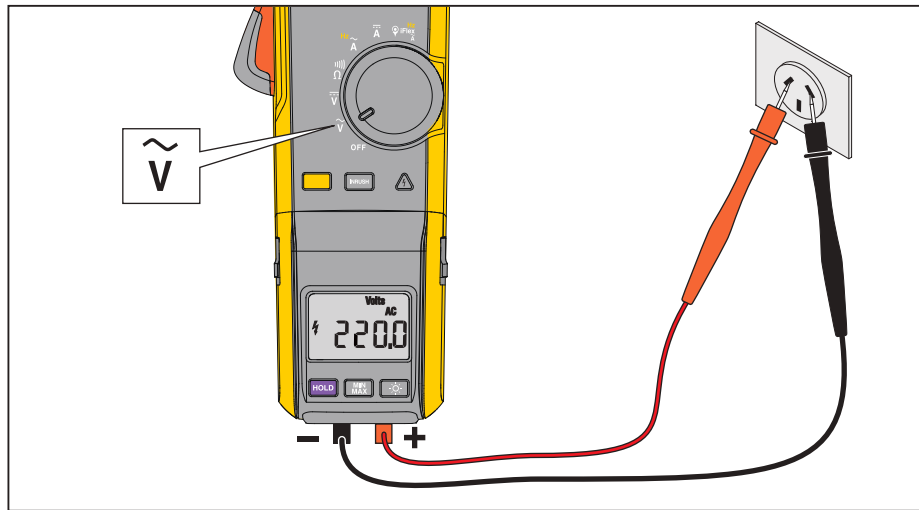

Resistance/Continuity

To measure resistance or continuity:

1. Turn the Rotary Function Switch to Ω .
2. Remove power from the circuit being tested.
3. Connect the black test lead to the **COM** terminal and the red test lead to the $\text{V}\Omega$ terminal.
4. Measure the resistance by touching the probes to the desired test points of the circuit.
5. View the reading on the display.

If the resistance is $<30 \Omega$, continuity is indicated by a beeper continuously sounding. If the display reads **OL**, the circuit is open.

Inrush Current Measurement (Jaw and Flexible Current Probe)

The Meter can capture the initial inrush current when starting a device such as a motor or light ballast.

To measure the inrush current:

1. With the device under test off, turn the Meter Rotary Function Switch to $\text{Hz} \sim \text{A}$, $\overline{\text{A}}$, or $\text{Hz} \text{ iFlex} \text{ A}$ if the Flexible Current Probe is being used for the measurement.
2. Center the Jaw or Flexible Current Probe around the device's live wire.
3. Push **INRUSH** on the Meter.
4. Turn on the device under test. The inrush current (spike) is displayed on the Meter display. See [Figure 5](#).

Figure 5. Inrush Current Measurement

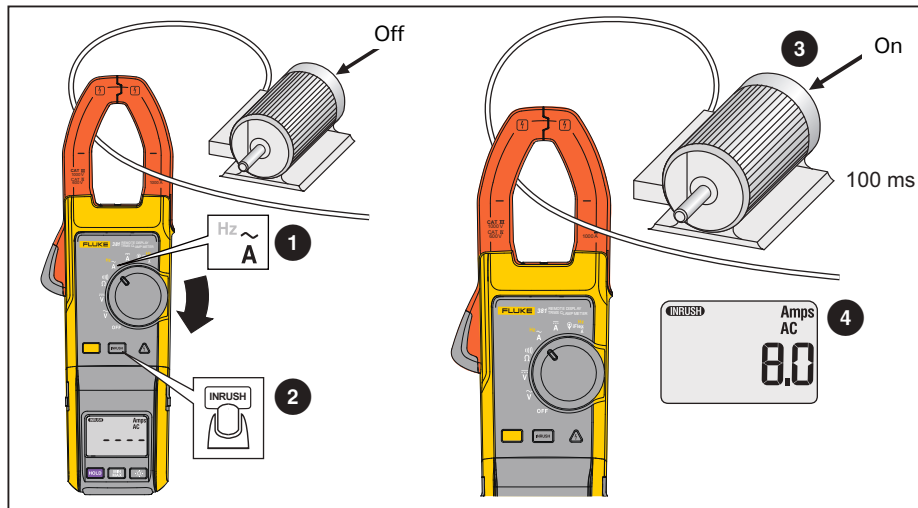

Frequency Measurement (Jaw and Flexible Current Probe)

To measure frequency:

1. Turn the Meter Rotary Function Switch to $\text{Hz} \sim \text{A}$ or $\text{Hz} \text{ iFlex} \text{ A}$ if the Flexible Current Probe is being used for the measurement.
2. Center the Jaw or Flexible Current Probe around the measurement source.
3. Push **ZERO** on the Meter to shift to Hz. The frequency is displayed on the Meter display.

Maintenance

Warning

To prevent possible electric shock or personal injury, repairs or servicing not covered in this manual should be performed only by qualified personnel.

Cleaning the Meter and Flexible Current Probe

Warning

To prevent electrical shock, remove any input signals before cleaning.

Caution

To prevent damage to the Meter, do not use aromatic hydrocarbons or chlorinated solvents for cleaning. These solutions will react with the plastics used in the Meter. Do not immerse the Meter in water.

Clean the instrument case with a damp cloth and mild detergent.

Battery Replacement

To replace the batteries in the Meter body, see [Figure 6](#):

1. Turn off the Meter.
2. Use a flat head screwdriver to loosen the battery compartment door screw on the Meter base, and remove the door from the case bottom.
3. Remove the batteries.
4. Replace the batteries with three new AAA batteries.
5. Reattach the battery compartment door to the case bottom and tighten the screw.

To replace the batteries in the display module, see [Figure 6](#):

1. Turn off the Meter.
2. Using the two latches on the side of the Meter, remove the display module.
3. On the bottom of the display module, there is a flat section in the center of the module. With your thumb, push down and slide the door towards you to open the battery compartment.
4. Remove the batteries.
5. Replace the batteries with two new AAA batteries.

6. Slide the battery door back into place.
7. Dock the Display Module with the Meter base and turn on the Meter.

Figure 6. Battery Replacement

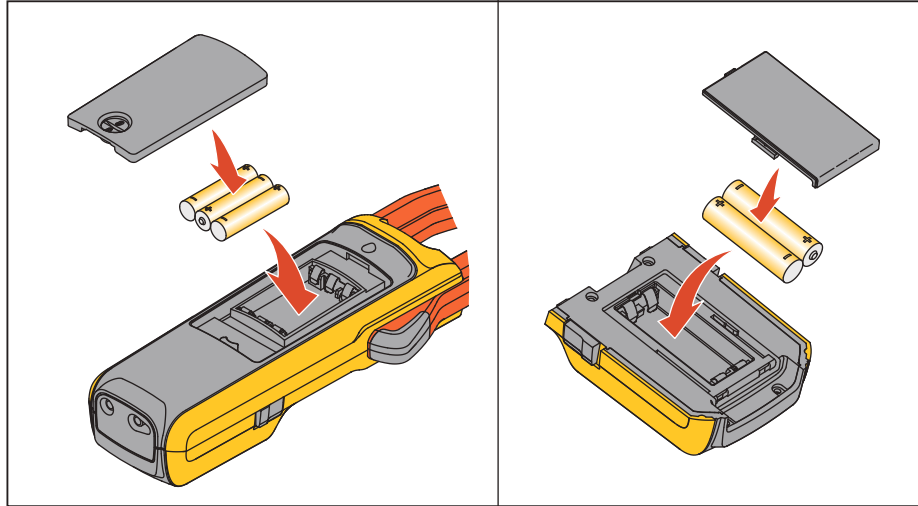

Product Disposal

Dispose of the Product in a professional and environmentally sound manner:

- Delete personal data on the Product before disposal.
- Remove batteries that are not integrated into the electrical system before disposal and dispose of batteries separately.
- If this Product has an integral battery, put the entire Product in the electrical waste.

User-Replaceable Parts

Table 4. User-Replaceable Parts

Description	Qty.	Fluke Part Number
Battery, AAA 1.5 V	5	2838018
Battery Door - Display Module	1	3625529
Battery Door - Meter Base	1	3766406
Remote Display	1	3766445
Soft Case	1	3752973

Specifications

Electrical Specifications

Temperature Coefficients, add 0.1 x specified accuracy for each degree C >28 °C or <18 °C.

AC Current Via Jaw

Range.....	999.9 A
Resolution	0.1 A
Accuracy	2 % ±5 digits (10 Hz to 100 Hz) 5 % ±5 digits (100 Hz to 500 Hz)
Crest Factor (50/60 Hz).....	3 @ 500 A 2.5 @ 600 A 1.42 @1000 A Add 2 % for C.F. >2

AC Current via Flexible Current Probe

Range.....	999.9 A / 2500 A (45 Hz to 500 Hz)
Resolution	0.1 A / 1 A
Accuracy	3 % ±5 digits
Crest Factor (50/60Hz).....	3.0 @ 1100 A 2.5 @ 1400 A 1.42 @ 2500 A Add 2 % for C.F. >2

Position Sensitivity

Table 5. Position Sensitivity

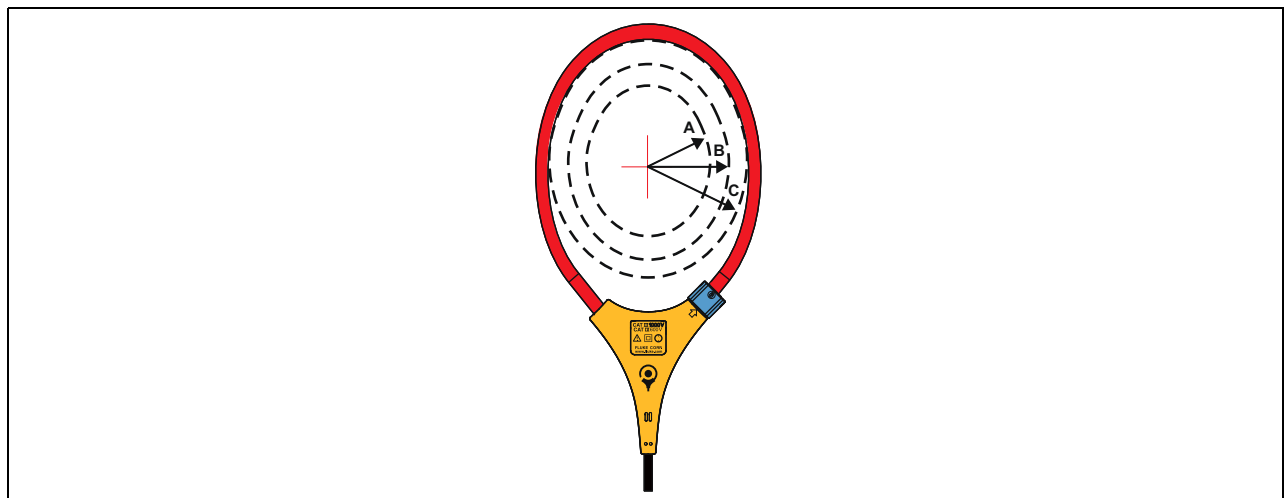

Distance from Optimum	i2500-10 Flex	i2500-18 Flex	Error
A	0.5 in (12.7 mm)	1.4 in (35.6 mm)	±0.5 %
B	0.8 in (20.3 mm)	2.0 in (50.8 mm)	±1.0 %
C	1.4 in (35.6 mm)	2.5 in (63.5 mm)	±2.0 %

Measurement uncertainty assumes centralized primary conductor at optimum position, no external electrical or magnetic field, and within operating temperature range.

DC Current

Range..... 999.9 A
Resolution 0.1 A
Accuracy..... 2 % \pm 5 digits

AC Voltage

Range..... 600 V /1000 V
Resolution 0.1 V / 1 V
Accuracy..... 1.5 % \pm 5 digits (20 Hz to 500 Hz)

DC Voltage

Range..... 600.0 V /1000 V
Resolution 0.1 V / 1 V
Accuracy..... 1 % \pm 5 digits

Frequency with Jaw

Range..... 5.0 Hz to 500.0 Hz
Resolution 0.1 Hz
Accuracy..... 0.5 % \pm 5 digits
Trigger Level..... 5 Hz to 10 Hz, \geq 10 A
10 Hz to 100 Hz, \geq 5 A
100 Hz to 500 Hz, \geq 10 A

Frequency with Flexible Current Probe

Range..... 5.0 Hz to 500.0 Hz
Resolution 0.1 Hz
Accuracy..... 0.5 % \pm 5 digits
Trigger Level..... 5 Hz to 20 Hz, \geq 25 A
20 Hz to 100 Hz, \geq 20 A
100 Hz to 500 Hz, \geq 25 A

Resistance

Range..... 600 Ω /6 k Ω /60 k Ω
Resolution 0.1 Ω /1 Ω /10 Ω
Accuracy..... 1 % \pm 5 digits

Mechanical Specifications

Size (L x W x H)..... 277 mm x 88 mm x 43 mm (55 mm for remote unit)
Weight 350 g
Jaw Opening 34 mm
Flexible Current Probe Diameter 7.5 mm
Flexible Current Probe Cable Length
(head to electronics connector) 1.8 m