

772/773

Milliamp Process Clamp Meter

Calibration Manual

LIMITED WARRANTY AND LIMITATION OF LIABILITY

This Fluke product will be free from defects in material and workmanship for 3 years (one year for cable and clamp) from the date of purchase. Parts, product repairs, and services are warranted for 90 days. This warranty extends only to the original buyer or end-user customer of a Fluke authorized reseller, and does not apply to fuses, disposable batteries, or to any product which, in Fluke's opinion, has been misused, altered, neglected, contaminated, or damaged by accident or abnormal conditions of operation or handling. Fluke warrants that software will operate substantially in accordance with its functional specifications for 90 days and that it has been properly recorded on non-defective media. Fluke does not warrant that software will be error free or operate without interruption.

Fluke authorized resellers shall extend this warranty on new and unused products to end-user customers only but have no authority to extend a greater or different warranty on behalf of Fluke. Warranty support is available only if product is purchased through a Fluke authorized sales outlet or Buyer has paid the applicable international price. Fluke reserves the right to invoice Buyer for importation costs of repair/replacement parts when product purchased in one country is submitted for repair in another country.

Fluke's warranty obligation is limited, at Fluke's option, to refund of the purchase price, free of charge repair, or replacement of a defective product which is returned to a Fluke authorized service center within the warranty period.

To obtain warranty service, contact your nearest Fluke authorized service center to obtain return authorization information, then send the product to that service center, with a description of the difficulty, postage and insurance prepaid (FOB Destination). Fluke assumes no risk for damage in transit. Following warranty repair, the product will be returned to Buyer, transportation prepaid (FOB Destination). If Fluke determines that failure was caused by neglect, misuse, contamination, alteration, accident, or abnormal condition of operation or handling, including overvoltage failures caused by use outside the product's specified rating, or normal wear and tear of mechanical components, Fluke will provide an estimate of repair costs and obtain authorization before commencing the work. Following repair, the product will be returned to the Buyer transportation prepaid and the Buyer will be billed for the repair and return transportation charges (FOB Shipping Point).

THIS WARRANTY IS BUYER'S SOLE AND EXCLUSIVE REMEDY AND IS IN LIEU OF ALL OTHER WARRANTIES, EXPRESS OR IMPLIED, INCLUDING BUT NOT LIMITED TO ANY IMPLIED WARRANTY OF MERCHANTABILITY OR FITNESS FOR A PARTICULAR PURPOSE. FLUKE SHALL NOT BE LIABLE FOR ANY SPECIAL, INDIRECT, INCIDENTAL OR CONSEQUENTIAL DAMAGES OR LOSSES, INCLUDING LOSS OF DATA, ARISING FROM ANY CAUSE OR THEORY.

Since some countries or states do not allow limitation of the term of an implied warranty, or exclusion or limitation of incidental or consequential damages, the limitations and exclusions of this warranty may not apply to every buyer. If any provision of this Warranty is held invalid or unenforceable by a court or other decision-maker of competent jurisdiction, such holding will not affect the validity or enforceability of any other provision.

Fluke Corporation
P.O. Box 9090
Everett, WA 98206-9090
U.S.A.

Fluke Europe B.V.
P.O. Box 1186
5602 BD Eindhoven
The Netherlands

ООО «Флюк СИИЭС»
125167, г. Москва, Ленинградский
проспект дом 37,
корпус 9, подъезд 4, 1 этаж

Table of Contents

Title	Page
Introduction	1
How to Contact Fluke.....	2
Safety Information.....	2
Symbols	5
Specifications	6
Electrical Specifications.....	6
Mechanical Specifications	7
Environmental Specifications	7
Miscellaneous Specifications.....	7
Basic Maintenance.....	9
How to Clean the Meter.....	9
Battery Replacement	9
Performance Tests.....	10
Required Equipment.....	10
How to Test the Batteries	11
How to Test the Display.....	11
Display Hold Test.....	11
Backlight Test	11
Measurement Spotlight LED Test.....	11
Accuracy Tests.....	12
mA DC Clamp Measure Accuracy Tests	12
mA DC Measure Accuracy Tests	12
Volts DC Measure Accuracy Tests.....	13
mA DC Source Accuracy Tests	13
Volts DC Source Accuracy Tests	13
Calibration Adjustment	14
Calibration Error Messages	15
mA DC Clamp Measure Adjustment Procedure.....	16
mA DC Measure Adjustment Procedure	16
Volts DC Measure Adjustment Procedure.....	16
mA DC Source Adjust Procedure	17
Volts DC Source Adjust Procedure (773 Only).....	17
Replaceable Parts.....	18

Introduction

Warning

To prevent electrical shock or personal injury, do not do the calibration verification tests or calibration procedures in this manual unless you are qualified.

The data in this manual is for qualified personnel only.

This manual tells you about verification and adjustment procedures for the 772/773 Milliamp Process Clamp Meter (referred to in this manual as the Meter or Product). The Meter features closed-case calibration to use with reference sources. It measures the reference signals, calculates the correction factors, and keeps them in memory. Calibration adjustment is required after a repair, or if the Meter fails a performance test.

This manual explains:

- Precautions and Safety Information
- Specifications
- Basic Maintenance
- Calibration/Verification Procedure
- Replaceable Parts and Accessories

For complete use instructions, refer to the *772/773 Instruction Sheet*.

How to Contact Fluke

To contact Fluke, call one of the following telephone numbers:

- Technical Support USA: 1-800-44-FLUKE (1-800-443-5853)
- Calibration/Repair USA: 1-888-99-FLUKE (1-888-993-5853)
- Canada: 1-800-36-FLUKE (1-800-363-5853)
- Europe: +31 402-675-200
- Japan: +81-3-3434-0181
- Singapore: +65-6799-5566
- China: +86-400-921-0835
- Brazil: +55-11-3530-8901
- Anywhere in the world: +1-425-446-5500

Or, visit Fluke's website at www.fluke.com.

To register your product, visit <http://register.fluke.com>.

To view, print, or download the latest manual supplement, visit <http://us.fluke.com/usen/support/manuals>.

Safety Information

A **Warning** identifies conditions and procedures that are dangerous to the user.

A **Caution** identifies conditions and procedures that can cause damage to the Product or the equipment under test.

Warning

To prevent possible electrical shock, fire, or personal injury:

- **Carefully read all instructions.**
- **Do not alter the Product and use only as specified, or the protection supplied by the Product can be compromised.**
- **Read all safety information before you use the Product.**
- **Do not use in CAT III or CAT IV environments without the protective cap installed on test probe. The protective cap decreases the exposed probe metal to <4 mm. This decreases the possibility of arc flash from short circuits.**
- **Comply with local and national safety codes. Use personal protective equipment (approved rubber gloves, face protection, and flame-resistant clothes) to prevent shock and arc blast injury where hazardous live conductors are exposed.**
- **Do not touch voltages >30 V ac rms, 42 V ac peak, or 60 V dc.**
- **Remove the batteries if the Product is not used for an extended period of time, or if stored in temperatures above 50 °C. If the batteries are not removed, battery leakage may result.**

- The battery door must be closed and locked before you operate the Product.
- Replace the batteries when the low battery indicator shows to prevent incorrect measurements.
- Do not apply more than the rated voltage, between the terminals or between each terminal and earth ground.
- Measure a known voltage first to make sure that the Product operates correctly.
- Use the Clamp only on insulated conductors. Use caution around bare conductors or bus bars. To prevent electrical shock, do not touch the conductor.
- Do not use test leads if they are damaged. Examine the test leads for damaged insulation, exposed metal, or if the wear indicator shows. Check test lead continuity.
- Hold the Product behind the tactile barrier. See Figure 1.
- Keep fingers behind the finger guards on the probes.
- Remove all probes, test leads, and accessories before the battery door is opened.
- Remove all probes, test leads, and accessories that are not necessary for the measurement.
- Do not exceed the Measurement Category (CAT) rating of the lowest rated individual component of a Product, probe, or accessory.
- Do not use the Product if it operates incorrectly.
- Disable the Product if it is damaged.
- Do not make connections on hazardous live conductors in damp or wet environments.

⚠ Caution

To prevent damage to the Meter, do not open it. Do not use a solvent to clean the Meter, and do not put the Meter in water.

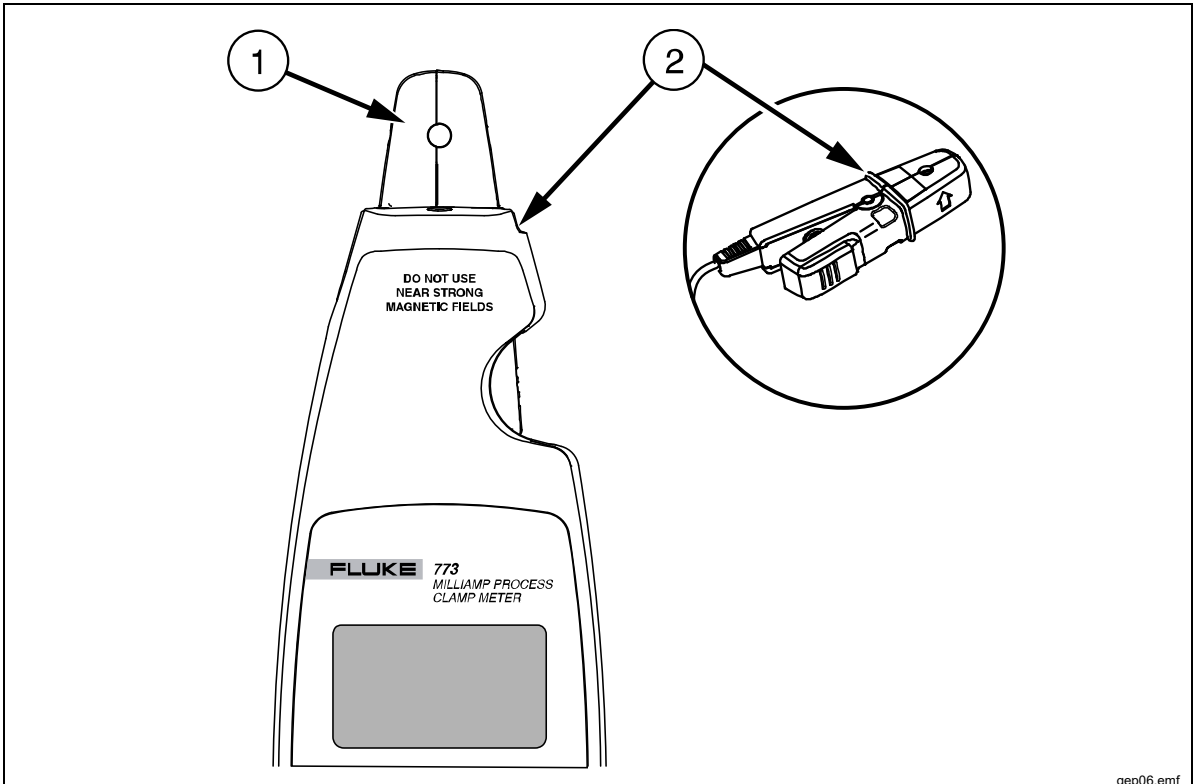

gep06.emf













Number	Description
①	Detachable clamp
②	Tactile Barrier docked and un-docked.

Figure 1. Tactile Barrier

Symbols

Table 1 is a list of the symbols that are on the Meter or in this manual.

Table 1. Symbols

Symbol	Explanation
	Consult user documentation.
	WARNING. RISK OF DANGER.
	WARNING. HAZARDOUS VOLTAGE. Risk of electric shock.
	Power on/off
	Do not apply around or remove from uninsulated hazardous live conductors without taking additional protective measures.
	Double Insulated
	DC (Direct Current)
	Earth Ground
	Battery
	Conforms to European Union directives.
	Conforms to relevant Australian Safety and EMC standards.
	Certified by CSA Group to North American safety standards.
CAT II	Measurement Category II is applicable to test and measuring circuits connected directly to utilization points (socket outlets and similar points) of the low-voltage MAINS installation.
CAT III	Measurement Category III is applicable to test and measuring circuits connected to the distribution part of the building's low-voltage MAINS installation.
CAT IV	Measurement Category IV is applicable to test and measuring circuits connected at the source of the building's low-voltage MAINS installation.
	This product complies with the WEEE Directive marking requirements. The affixed label indicates that you must not discard this electrical/electronic product in domestic household waste. Product Category: With reference to the equipment types in the WEEE Directive Annex I, this product is classed as category 9 "Monitoring and Control Instrumentation" product. Do not dispose of this product as unsorted municipal waste.

Specifications

Electrical Specifications

DC Current Measurement

With Jaw

Ranges 0 mA to 20.99 mA, 21 mA to 100 mA
Resolution 0.01 mA, 0.1 mA
Accuracy..... 0.2 % + 5 counts, 1 % + 5 counts

In Circuit

Range 0 mA to 24 mA
Resolution 0.01 mA
Accuracy..... 0.2 % + 2 counts

Current Source

Range 0 mA to 24 mA
Resolution 0.01 mA
Accuracy..... 0.2 % + 2 counts
mA Drive..... 24 mA into 1000 Ω

Current Simulate

Range 0 mA to 24 mA
Resolution 0.01 mA
Accuracy..... 0.2 % + 2 counts
Maximum Voltage 50 V

DC Voltage Measurement (773)

Range 0-30 V
Resolution..... 0.01 V
Accuracy..... 0.2 % + 2 counts

DC Voltage Source (773)

Range 0 V to 30 V
Resolution 0.01 V
Accuracy..... 0.2 % + 2 counts
mA Drive..... 2 mA maximum all conditions

mA DC IN/OUT (773)

Sourcing range 0 mA to 24 mA
Sourcing resolution 0.01 mA
Sourcing accuracy 0.2 % + 2 counts
Measurement range 0 mA to 24 mA
Measurement resolution 0.01 mA
Measurement accuracy 1 % FS

Scaled mA DC Current Output to mA Current Input from the Jaw (773)

Range 0 mA to 24 mA
Resolution 0.01 mA
Accuracy..... 1 % FS
Response speed..... 2x/second
DC Loop Power 24 V
Influence of Earth's Field <0.20 mA
Batteries 4 1.5 V, Alkaline, IEC LR6
Working hours 12 hours @ 12 mA sourced into 500 Ω

Mechanical Specifications

Size (H X W X L) 43.7 mm x 70 mm x 246.2 mm
Weight..... 410 g

Environmental Specifications

Operating Temperature..... -10 °C to 50 °C
Storage Temperature -25 °C to 60 °C
Operating Humidity <90 % RH @ <30 °C
 <75 % RH @ 30 °C to 50 °C
Operating Altitude 0 m to 2000 m
IP Rating IP 40
Temperature Coefficients..... 0.1 (/ °C X Specified accuracy for Temperature <18 °C or >28 °C)
Safety..... IEC 61010-1, Pollution degree 2
 IEC 61010-2-032: O, other circuits not directly connected to mains.
Electromagnetic Compatibility (EMC)
International IEC 61326-1: Portable Electromagnetic Environment
 IEC 61326-2-2
 CISPR 11: Group 1, Class A

Group 1: Equipment has intentionally generated and/or uses conductively-coupled radio frequency energy that is necessary for the internal function of the equipment itself.

Class A: Equipment is suitable for use in all establishments other than domestic and those directly connected to a low voltage power supply network that supplies buildings used for domestic purposes. There may be potential difficulties in ensuring electromagnetic compatibility in other environments due to conducted and radiated disturbances.

Caution: This equipment is not intended for use in residential environments and may not provide adequate protection to radio reception in such environments.

Emissions that exceed the levels required by CISPR 11 can occur when the equipment is connected to a test object.

The equipment may not meet the immunity requirements of this standard when test leads and/or test probes are connected.

For current measurement with jaw, add 1 mA to specification for EMC fields from 1 V/m to 3 V/m.

Miscellaneous Specifications

Power Requirements Four AA batteries, Alkaline, IEC LR6
Automatic Time-out (Power) 15 minutes ±1 minute
Automatic Time-out (Backlight) 2 minutes ±10 seconds
Automatic Time-out
(Measurement Spotlight)..... 2 minutes ±10 seconds



Static Awareness



Semiconductors and integrated circuits can be damaged by electrostatic discharge during handling. This notice explains how to minimize damage to these components.

1. Understand the problem.
2. Learn the guidelines for proper handling.
3. Use the proper procedures, packaging, and bench techniques.

Follow these practices to minimize damage to static sensitive parts.

Warning

To prevent electric shock or personal injury. De-energize the product and all active circuits before opening a product enclosure, touching or handling any PCBs or components.

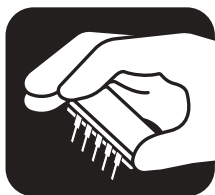

- Minimize handling.
- Handle static-sensitive parts by non-conductive edges.
- Do not slide static-sensitive components over any surface.
- When removing plug-in assemblies, handle only by non-conductive edges.
- Never touch open-edge connectors except at a static-free work station.

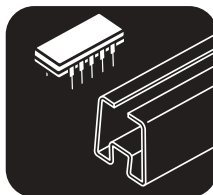

- Keep parts in the original containers until ready for use.
- Use static shielding containers for handling and transport.
- Avoid plastic, vinyl, and Styrofoam® in the work area.



- Handle static-sensitive parts only at a static-free work station.
- Put shorting strips on the edge of the connector to help protect installed static-sensitive parts.
- Use anti-static type solder extraction tools only.
- Use grounded-tip soldering irons only.

Basic Maintenance

Warning

To prevent possible electric shock, fire, or personal injury:

- Remove the input signals before you clean the Product.
- Repairs or servicing not covered in this manual should be performed only by qualified personnel.
- Replace all batteries with fresh batteries of the same manufacturer and type to prevent battery leakage.

How to Clean the Meter

Caution

To prevent damage to the Meter, do not use aromatic hydrocarbons or chlorinated solvents when you clean the Meter. These solutions react with the plastics used in the Meter.

Clean the instrument case with a damp cloth and mild detergent.

Battery Replacement

Warning

To prevent possible electric shock, fire, or personal injury:

- To avoid false readings, that could lead to possible electrical shock or personal injury, replace the batteries as soon as the battery indicator () appears.
- Remove test leads before changing the batteries.

To replace the batteries, see Figure 2:

1. Turn the Meter off.
2. Use a flat-head screwdriver to loosen the battery compartment door screws and remove the door from the case bottom.
3. Remove the batteries.
4. Replace the batteries with four new AA batteries.
5. Reattach the battery compartment door to the case bottom and tighten the screws.

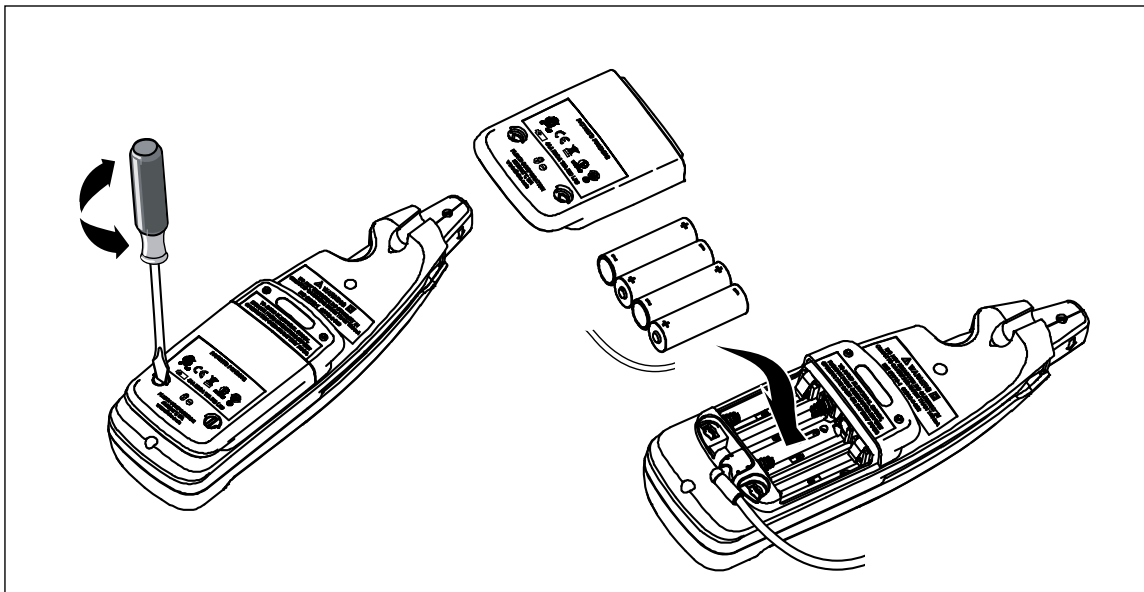

Figure 2. Battery Replacement

gep02.emf

Performance Tests

⚠⚠ Warning

To prevent electrical shock, personal injury, or fire:

- Repairs or Meter servicing must be done only by qualified personnel.
- Do not do the verification tests or calibration adjustment in this manual unless qualified.

The tests that follow verify the functions of the Meter. If the Meter fails the verification tests, repair is necessary. For Meter servicing, see *How to Contact Fluke*.

Required Equipment

Required equipment for the performance tests is in Table 2. If the recommended models are not available, equipment with equivalent specifications can be used.

Table 2. Required Equipment

Equipment	Minimum Required Characteristics	Recommended Model
Calibrator	DC milliamps: 0-24.00 mA = ± 0.073 % 24.0-100.0 mA = ± 0.375 % DC Volts: 0-30.00 V = ± 0.267 %	Fluke 55xxA
DMM	DC Current: 0-24.00 mA = ± 0.375 % DC Volts: 0-10 V = ± 0.1 %	Fluke 88xxA
Lab Supply	6 Vdc ± 0.5 V	-

How to Test the Batteries

Prior to performing the following tests, check the batteries with a multimeter and replace as necessary. See *Battery Replacement*.

How to Test the Display

1. Push and hold **HOLD** while powering on the Meter.
2. Compare the Meter display to Figure 3.
3. Examine all display segments for clarity and contrast.

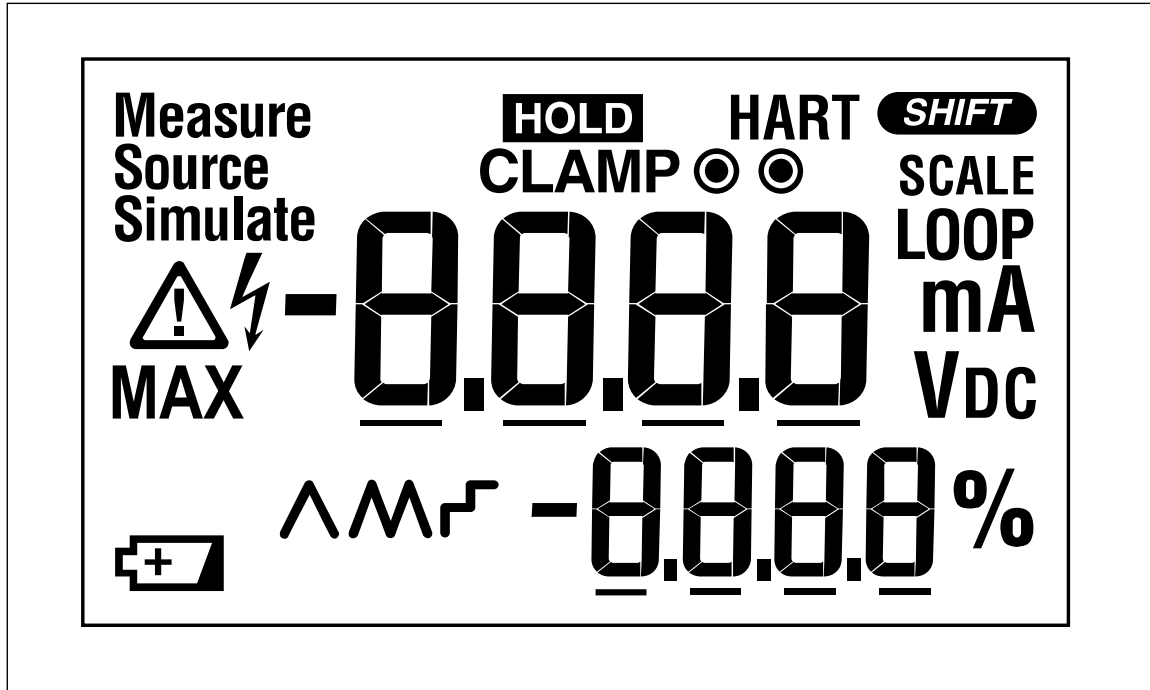

Figure 3. Display Test

gep07.emf

Display Hold Test

Warning

To prevent possible electrical shock, fire, or personal injury:

- Be aware of the measurement being taken when using Display HOLD. When Display HOLD is activated, the display will not change when different currents are applied.
- Do not use the HOLD function to measure unknown potentials. When HOLD is turned on, the display does not change when a different potential is measured.

Push **HOLD** to activate Display Hold mode. The display shows **HOLD** and the display freezes. Push **HOLD** a second time to exit and resume normal operation.

Backlight Test

Push  to turn the backlight on and off. To extend battery life, the backlight automatically stops after 2 minutes.

Measurement Spotlight LED Test

Push  to activate the Measurement Spotlight LED. To extend battery life, the light automatically stops after 2 minutes.

Accuracy Tests

Accuracy specifications are valid for 1 year after calibration adjustment when measured at an operation temperature of 18 °C to 28 °C. Allow the Meter to stabilize at room temperature prior to performing the accuracy tests.

The following tables list the required performance test points for verifying Meter accuracy. Zero the Meter prior to completing each measurement point.

mA DC Clamp Measure Accuracy Tests

Step	Calibrator Output	UUT Meter Reading Limit	
		Low	High
1	4.00 mA	3.94 mA	4.06 mA
2	-4.00 mA	-4.06 mA	-3.94 mA
3	12.00 mA	11.03 mA	12.07 mA
4	-12.00 mA	-12.07 mA	-11.03 mA
5	20.00 mA	19.01 mA	20.09 mA
6	-20.00 mA	-20.09 mA	-19.01 mA
7	100.0 mA	98.5 mA	101.5 mA
8	-100.0 mA	-101.5 mA	-98.5 mA

mA DC Measure Accuracy Tests

Step	Calibrator Output	UUT Meter reading limit	
		Low	High
1	0.00 mA	-0.02 mA	0.02 mA
2	4.00 mA	3.97 mA	4.03 mA
3	-4.00 mA	-4.03 mA	-3.97 mA
4	8.00 mA	7.96 mA	8.04 mA
5	-8.00 mA	-8.04 mA	-7.96 mA
6	12.00 mA	11.96 mA	12.04 mA
7	-12.00 mA	-12.04 mA	-11.96 mA
8	20.00 mA	19.94 mA	20.06 mA
9	-20.00 mA	-20.06 mA	-19.94 mA
10	24.00 mA	23.93 mA	24.07 mA
11	-24.00 mA	-24.07 mA	-23.93 mA

Volts DC Measure Accuracy Tests

Step	Calibrator Output	UUT Meter Reading Limit	
		Low	High
1	0.00 V	-0.02 V	0.02 V
2	10.00 V	9.96 V	10.04 V
3	-10.00 V	-10.04 V	-9.96 V
4	20.00 V	19.94 V	20.06 V
5	-20.00 V	-20.06 V	-19.94 V
6	30.00 V	29.92 V	30.08 V
7	-30.00 V	-30.08 V	-29.92 V

mA DC Source Accuracy Tests

Step	UUT Meter Output	DMM Reading Limit	
		Low	High
1	0.00 mA	-0.02 mA	0.02 mA
2	4.00 mA	3.97 mA	4.03 mA
3	8.00 mA	7.96 mA	8.04 mA
4	12.00 mA	11.96 mA	12.04 mA
5	20.00 mA	19.94 mA	20.06 mA
6	24.00 mA	23.93 mA	24.07 mA

Volts DC Source Accuracy Tests

Step	UUT Meter Output	DMM Reading Limit	
		Low	High
1	0.00 V	-0.02 V	0.02 V
2	2.50 V	2.47 V	2.53 V
3	5.00 V	4.97 V	5.03 V
4	7.50 V	7.46 V	7.54 V
5	10.00 V	9.96 V	10.04 V

Calibration Adjustment

The Meter features closed-case calibration adjustment with a known reference source. The Meter measures the applied reference source, calculates correction factors, and keeps the correction factors in nonvolatile memory.

Before you start calibration adjustment, let the Meter stabilize to room temperature.

To turn on Calibration mode:

1. Remove the batteries and substitute with a lab supply set to 6 V dc.
2. Open the battery door. The calibration button is usually hidden by the factory calibration seal.
3. Use a small probe and push the calibration button longer than 2 seconds. See Figure 4.

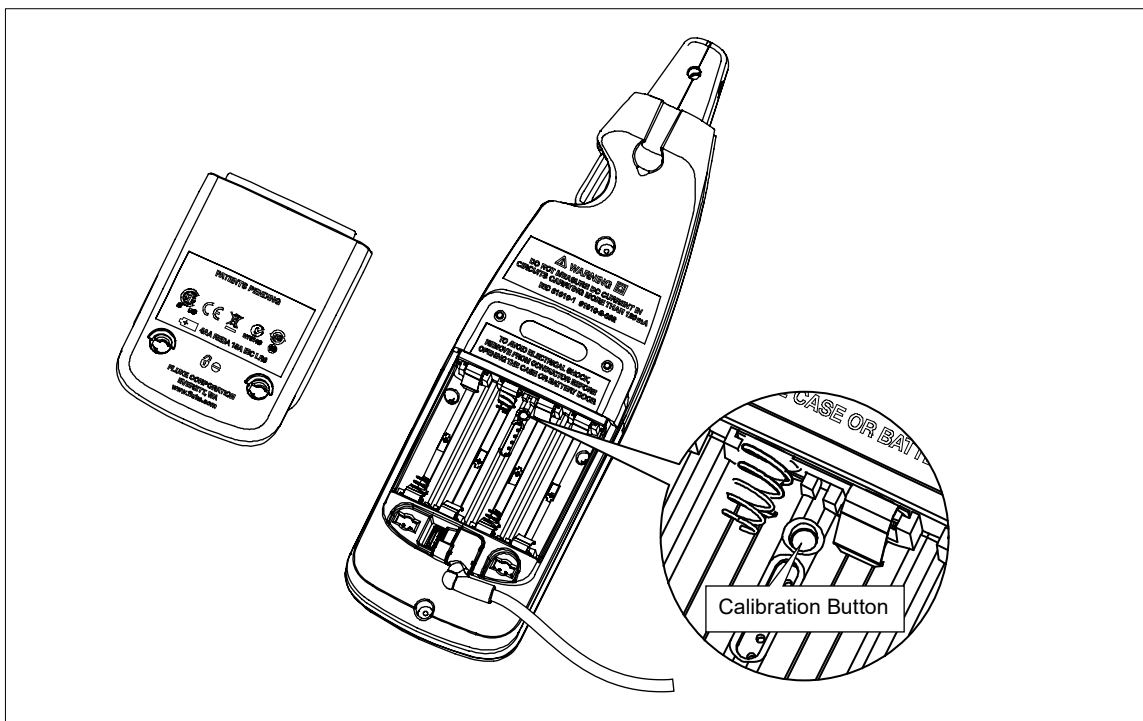

Figure 4. Accessing the Calibration Button

gep01.emf

There are five Meter functions to adjust:

1. Clamp measure
2. mA measure
3. Volt measure (773 only)
4. mA source
5. Volt source (773 only)

Table 3 shows the Meter buttons you use to select a function to be calibrated.

Table 3. Calibration Functions











Button	Calibration Function Description
	Engages mA function
	Identifies V dc function
	Identifies Clamp function
	Toggles between measure and source modes

Table 4 shows the Meter buttons you use to adjust the Meters calibration.

Table 4. Calibration Adjustments

Button	Calibration Adjustment Description
	A short button push (1 second) changes the Meter to the first calibration step A long button push exits the Meters calibration mode
 	Adjust source output in large steps
 	Adjust source output in small steps
	Forward to subsequent calibration step

The Meter display shows the value in each adjustment step.

- In Measure mode, the shown value is the calibrator input.
- In Source mode, the shown value is the Meter output.

To exit Calibration mode:

Push the calibration button a second time to keep new calibration constants and exit calibration mode.

Calibration Error Messages

The calibration error messages that the Meter can show are in Table 5. Steps to remove the messages are also shown in the table.

Table 5. Error Messages

Error Message	Cause of Error	Removal Steps
Cal	Meter not calibrated, use default parameter	Do all adjustments
Err	Code area checksum error	Meter repair is necessary

mA DC Clamp Measure Adjustment Procedure

To adjust the Clamp Measure function, use the Calibrator to apply the necessary Meter input and do the steps in Table 6.

Table 6. Clamp Measure Adjustment Procedure

Step	Meter Display	Calibrator Output	Procedure
1	0.00 mA	0.00 mA	Stop for 10 seconds, push HOLD
2	-20.00mA	-20.00 mA	Push HOLD
3	0.00mA	0.00 mA	Stop for 10 seconds, push HOLD
4	20.00mA	20.00 mA	Push HOLD
5	0.00 mA	0.00 mA	Stop for 10 seconds, push HOLD
6	-100.00mA	-100.00 mA	Push HOLD
7	0.00mA	0.00 mA	Stop for 10 seconds, push HOLD
8	10.00mA	100.00 mA	Push HOLD
9	Save	--	Push HOLD

mA DC Measure Adjustment Procedure

To adjust the mA Measure function, use the Calibrator to apply the necessary Meter input and do the steps in Table 7.

Table 7. mA Measure Adjustment Procedure

Step	Meter Display	Calibrator Output	Procedure
1	-20.00 mA	-20.00 mA	Push HOLD
2	0.00 mA	0.00 mA	Push HOLD
3	20.00 mA	20.00 mA	Push HOLD
4	Save	--	Push HOLD

Volts DC Measure Adjustment Procedure

To adjust the Volt Measure function, use the Calibrator to apply the necessary Meter input and do the steps in Table 8.

Table 8. Volt Measure Adjustment Procedure

Step	Meter Display	Calibrator Output	Procedure
1	-30.00V	-30.00 V	Push HOLD
2	0.00V	0.00 V	Push HOLD
3	30.00V	30.00 V	Push HOLD
4	Save	--	Push HOLD

mA DC Source Adjust Procedure

To adjust the mA Source function, use the Calibrator to apply the necessary Meter input and do the steps in Table 9.

Table 9. mA Source Adjustment Procedure

Step	Meter LCD display	Action
1	4.00 mA	Adjust until Meter output is 4.00 mA, push HOLD
2	20.00 mA	Adjust until Meter output is 20.00 mA, push HOLD
4	Save	Push HOLD

Volts DC Source Adjust Procedure (773 Only)

To adjust the Volt Source function, use the Calibrator to apply the necessary Meter input and do the steps in Table 10.

Table 10. Volt Source Adjustment Procedure

Step	Meter LCD display	Action
1	0.00 V	Adjust until Meter output is 0.00 V, push HOLD
2	10.00 V	Adjust until Meter output is 10.00 V, push HOLD
4	Save	Push HOLD

Replaceable Parts

Table 11 is a list of replaceable parts.

Table 11. Replaceable Parts

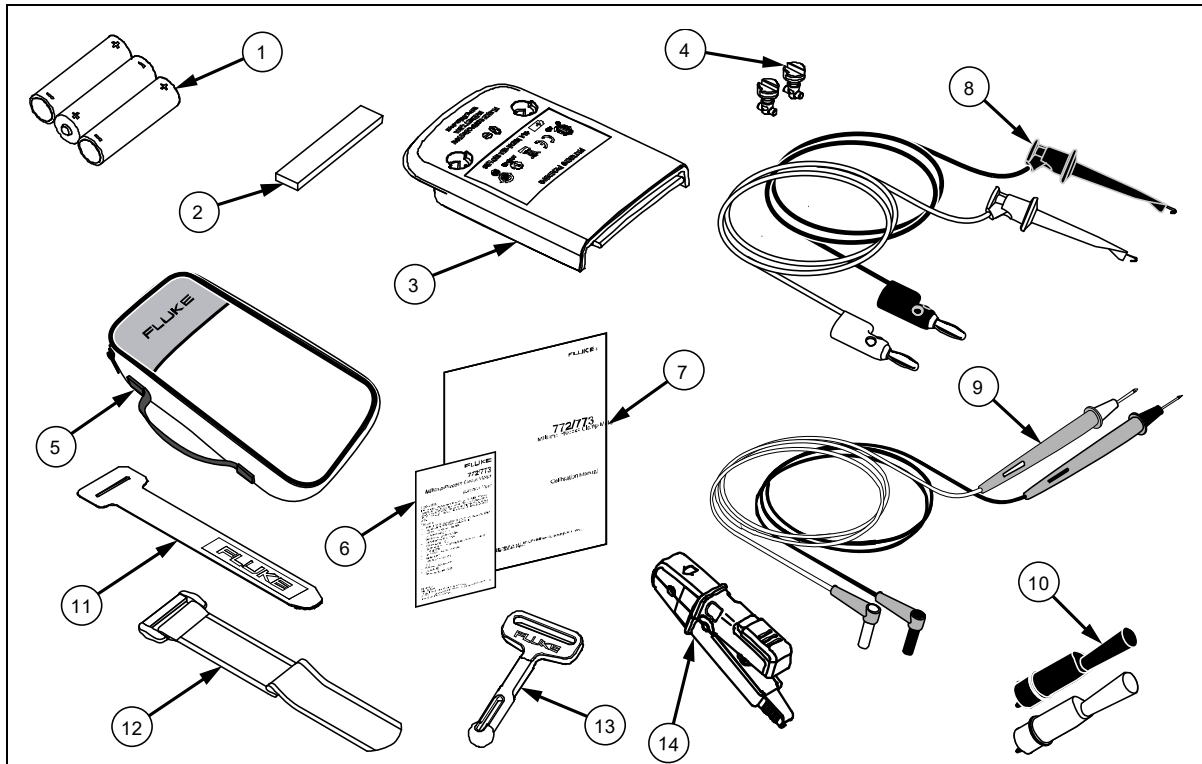

Item	Description	Quantity	Part or Model Number
①	AA Batteries, 1.5 V	4	376756
②	Absorber	1	3369914
③	Battery Door	1	3350978
④	Fastener	2	948609
⑤	Soft Carrying Case	1	3351060
⑥	Instruction Sheet	1	download from www.fluke.com
⑦	Calibration Manual	1	download from www.fluke.com
⑧	TL940 Mini Hook with Test Lead	1 Set	1616705
⑨	TL75- Test Leads	1 Set	855742
⑩	AC175 Alligator Clips	1 Set	4101772
⑪	Hook and Loop Strip	1	3031302
⑫	TPAK, Strap 17 inches	1	669967
⑬	Hanger	1	3375746
⑭	*Jaw Assembly	1 Set	3350957

*Re-calibration is required after jaw assembly is replaced.