

Model 705 Loop Calibrator

Calibration Information

Warning

To avoid electrical shock, remove test leads and any input signals from the Model 705 Loop Calibrator before opening the case.

Caution

The Model 705 Loop Calibrator contains parts that can be damaged by static discharge. Follow the standard practices for handling static sensitive devices.

Introduction

The *Calibration Information* for the Model 705 Loop Calibrator (hereafter referred to as the Loop Calibrator) provides the information necessary to calibrate and verify the performance of the Loop Calibrator.

This document includes the following:

- Contacting Fluke for service
- Specifications
- Cleaning
- Replacing the battery
- Disassembly and reassembly
- Recommended test equipment
- Performance verification procedures
- Calibration adjustments
- User-replaceable parts

Complete operating instructions and the warranty statement for the Model 705 Loop Calibrator are provided in the *Instruction Sheet* that came with it.

Contacting Fluke for Service

This Fluke product will be free from defects in material and workmanship for three years from the date of purchase.

The complete warranty statement is in the *Model 705 Loop Calibrator Instruction Sheet*.

To locate an authorized service center, visit us on the World Wide Web: www.fluke.com or call Fluke using the phone numbers listed below:

- 1-888-99FLUKE (1-800-993-5853) in USA
- 1-800-36-FLUKE (1-800-363-5853) in Canada
- +31 402-678-200 in Europe
- +81-3-3434-0181 in Japan
- +65-738-5655 in Singapore
- +1-425-356-5500 from other countries

Specifications

Product specifications are provided Tables 1 and 2. These specifications are based on a 1-year calibration cycle and apply from 18 °C to 28 °C (64 °F to 82 °F) unless stated otherwise. Accuracy specifications are given as follows:

$$\pm ([\% \text{ of reading}] + [\text{number of least significant digits}]).$$

Table 1. General Specifications





Maximum voltage between any terminal and earth ground or between any two terminals	30 V
Display:	0 to 28 V with 0.001 V resolution, 0 to 24 mA with 0.001 mA resolution
Operating Temperature:	-10 °C to 55 °C
Storage Temperature:	-40 °C to 60 °C
Temperature Coefficient:	± 0.005 % of range per °C for -0 °C to 18 °C and 28 °C to 55 °C
Relative Humidity:	95 % to 30 °C, 75 % to 40 °C, 45 % up to 50 °C, 35 % up to 55 °C
Operationing Altitude:	3000 meters maximum
Power Requirements:	Single 9 V battery (ANSI/NEDA 1604A or IEC 6LR61)
Battery Life (Typical):	Source Mode: 18 hours; 12 mA into 500 Ω Measure / Simulate Mode: 50 hours
Shock, Vibration:	1 meter drop test Random vibration 2 g @ 5 to 500 Hz
Size (H x W x L):	32 mm x 87 mm x 187 mm (1.25 in x 3.41 in x 7.35 in)
Weight:	349 g (12.3 oz). With Holster and flex-stand: 601 g (21.2 oz)
Safety	Certified as compliant to CAN/CSA C22.2 No. 1010.1:1992. Complies with ANSI/ISA S82.01-1994
Certification	CE and 

Table 2. Accuracy Specifications

Function	Range	Resolution	Accuracy
DC Volts Input	+ 28 V	0.001 V	± (0.025 % + 1)
DC mA Input	24 mA	0.001 mA	±(0.02 % + 2)
DC mA Output	0 mA to 24 mA	0.001 mA	± (0.02 % + 2)
	 0 % -100 % - 0 % 40 second smooth ramp		
	 0 % -100 % - 0 % 15 second smooth ramp		
	 0 % -100 % - 0 % Stair-step ramp in 25 % steps, pausing 5 seconds at each step		
Source mode:	Compliance: ≥ 1000 Ω at 20 mA		
Simulate mode:	External loop voltage requirements: 24 V nominal, 30 V maximum, 12 V minimum		
Loop Power	≥ 24 V		
Percent display	- 25 % to 125 %		
Input/Output protection	Input/Output protection on mA range: resettable, nonreplaceable 0.1 A fuse.		

Cleaning

⚠ Warning

To avoid electrical shock, remove test leads and input signals before cleaning.

To clean the case, wipe it with a cloth lightly dampened with water and a mild detergent.

Do not use abrasives, solvents, or alcohol.

Replacing the Battery

⚠ Warning

To avoid false readings, which could lead to possible electric shock or personal injury, replace the battery as soon as the low battery symbol () appears on the Loop Calibrator's display.

To replace the battery:

1. Lift and remove the battery cover to gain access the battery compartment. See Figure 1.
2. Lift the battery from the case bottom and insert a new 9 V battery.
3. Be sure the positive and negative battery posts are oriented correctly, as noted in the bottom of the battery compartment.

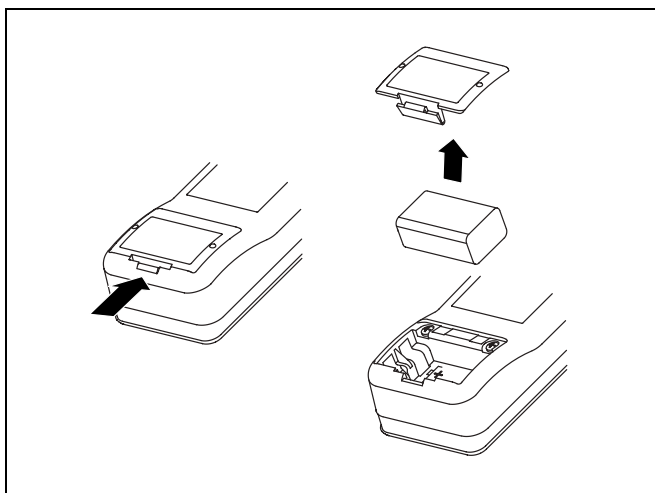

AAK07F.EPS

Figure 1. Replacing the Battery

Disassembling and Reassembling the Calibrator

⚠ Warning

To avoid electric shock or personal injury:

- Do not allow water into the case.
- Remove any input signals prior to removing test leads and opening case.
- When servicing the Loop Calibrator, use only specified replacement parts.

To disassemble and reassemble the Loop Calibrator, refer to Figures 2 and 3 as necessary and perform the following procedure.

Note

Both a Phillips-head screwdriver and a flat-blade screwdriver are required.

1. **To remove the printed circuit assembly (pca):** Remove all test leads from the terminals of the Loop Calibrator.
2. Set the rotary switch to **OFF**.
3. Lift and remove the battery cover to gain access to the battery compartment. Remove the battery.
4. Remove all Phillips-head screws from the case bottom.
5. Separate the case top from the case bottom.

Verify that the battery terminals are being guided through the bottom case before completely removing the case bottom.

6. Referring to Figure 3, insert a small, flat-blade screwdriver between the edge of the case top and the pca. Gently unsnap the case top from the pca.
7. Repeat step 6 for each of the remaining snaps that secure the pca to the case top.
8. Lift the pca from the case top by its edges.
9. If the elastomeric strips for the keypad assembly and LCD are stuck to the pca, remove them, but *do not touch the conductive edges*.

Note

Before reinserting the pca, make sure that the rotary knob is in the **OFF** position.

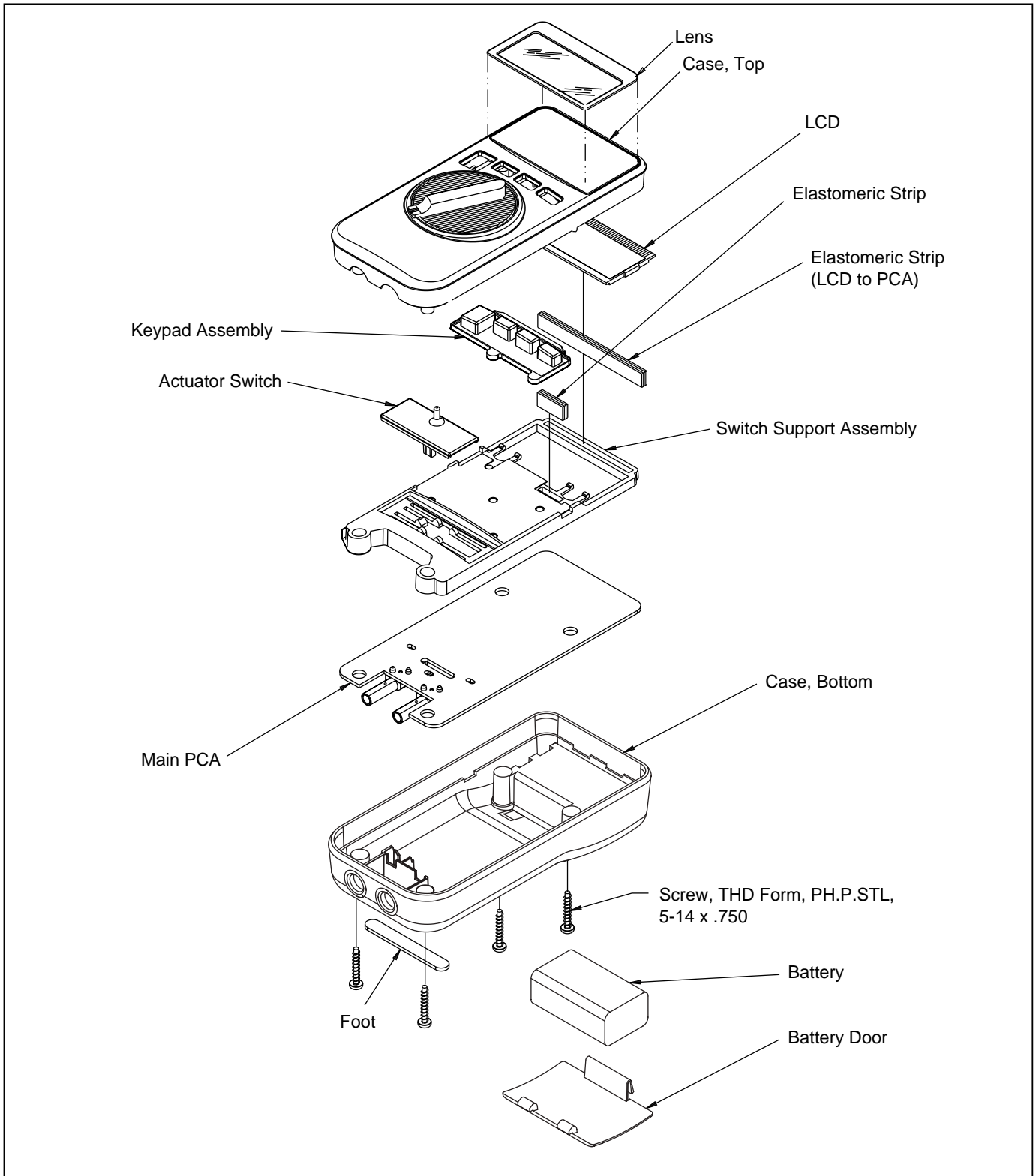

Figure 2. Disassembled Loop Calibrator

AAK10F.EPS

10. **To remove the switch support:** Use a small, flat-blade screwdriver to gently unsnap the sides and top of the switch support from the snaps shown in Figure 2.

The LCD, keypad assembly, and elastomeric strips are accessible and can be replaced as needed.

Do not allow the LCD to get wet.

Before installing a new LCD, make sure that all connector contact points are clean.

Caution

Do not touch the conductive edges of the elastomeric strips or the contacts on the keypad assembly. If they are contaminated, clean them with isopropyl alcohol.

11. **To reinsert the pca:** Place the pca over the four screw posts in the case top.

Gently press on the center of the pca while using the small flat-edge screwdriver to shoehorn the pca under the snap on a side of the case top. Repeat on the other side and the top.

12. **To reassemble to Calibrator:** Reassembling the Calibrator is the reverse of disassembling it.

After the Calibrator is reassembled, perform the verification test to confirm that the Loop Calibrator is working properly.

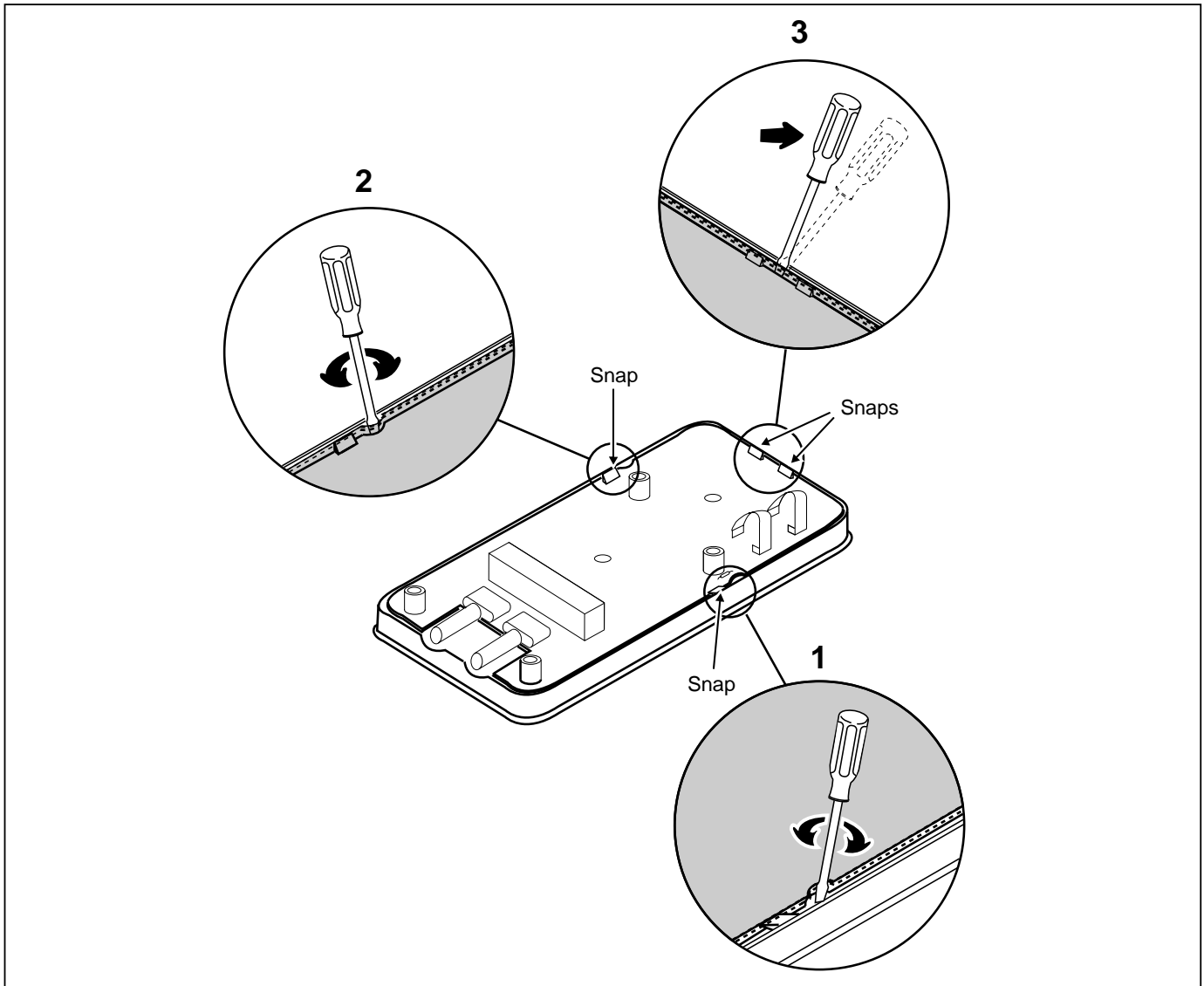

Figure 3. Removing and Reinserting the Printed Circuit Assembly (PCA)

AAK02F.EPS

Recommended Test Equipment

A list of recommended equipment for the performance verification tests and calibration adjustment procedure is shown in Table 3.

Performance Verification Procedures

⚠ Warning



To avoid electric shock, do not perform the verification tests unless the Loop Calibrator is fully assembled.

Perform the following tests to check the accuracy of each of the Loop Calibrator's functions against its specifications.

If the Loop Calibrator fails any of these tests, calibration adjustment or repair is required.

DC Current Source Mode

1. Rotate the Loop Calibrator's function switch from OFF to the **mA / SOURCE / SIMULATE / MEASURE** position.



The Loop Calibrator should display 4.000 mA. If it is displaying 0.000 mA, turn the Loop Calibrator off, press hold . Turn on the Loop Calibrator to the **mA** position. Continue to hold  until 4.000 mA is displayed (about three seconds).

2. Connect the Loop Calibrator's **[+]** terminal to the HP 3458A **I** input, and the **COM** terminal to the HP 3458 **LO** input.

Verify that the display shows **SOURCE** in the upper-left corner.

3. Set the HP 3458A to measure DC Amps (**DCI**).

Refer to Table 4 to verify the readings on the HP 3458A for the following tests. (No adjustment is necessary for test 1.)

4. Test 2: Press the  key twice to select 12.000 mA. Verify the readings.
5. Test 3: Press the  key twice to select 20.000 mA/ Press and hold the  key until 24.000 mA is displayed. Verify the readings.

DC Current Measurement Mode

1. Press the  key twice to get into the measurement mode.

The Loop Calibrator's display should read **MEASURE**.

2. Disconnect the HP 3458A from the Loop Calibrator.
3. Connect the test leads from the **AUX** terminals of the Fluke 5500A to the terminals on the Loop Calibrator (Black to **COM** and red to **[+]**).
4. Set the Fluke 5500A to test 4 in Table 4 and verify the display readings on the Loop Calibrator.

Repeat for tests 5 and 6.

The reading on the Loop Calibrator's display should be within the minimum and maximum values shown in Table 4.

Table 3. Recommended Equipment

Equipment	Minimum Specification	Recommended Model or Equivalent
DC Calibrator	DC Voltage: 0 to 30 V Accuracy: $\pm 0.005\%$ +50 μ V DC Current 0 to 24 mA Accuracy: $\pm 0.01\%$ +0.25 μ A	Fluke 5500A Multi-Product Calibrator
Digital Multimeter	DC Current: 0 to 26 mA Accuracy: ± 73 ppm	HP 3458A
Flexible Test Leads		Fluke TL24

Table 4. DC Current Source / Current Measure / Voltage Measure Mode Tests

Test No.	705 Loop Calibrator Output	Switch Position	HP 3458A Minimum	HP 3458A Maximum
1	4.000 mA	Center	3.997 mA	4.003 mA
2	12.000 mA	Center	11.995 mA	2.005 mA
3	24.000 mA	Center	23.993 mA	24.007 mA
	5500A Calibrator Output	Switch Position	Fluke 705 Minimum	Fluke 705 Maximum
4	4.000 mA	Center	3.997 mA	4.003 mA
5	12.000 mA	Center	11.995 mA	12.005 mA
6	24.000 mA	Center	23.993 mA	24.007 mA
	5500A Calibrator Output	Switch Position	Fluke 705 Minimum	Fluke 705 Maximum
7	0.000 V	Right	-0.001 V	0.001 V
8	14.000 V	Right	13.995 V	14.005 V
9	28.000 V	Right	27.992 V	28.008 V

DC Current Measurement Mode

1. Set the rotary switch on the Loop Calibrator to **V MEASURE**.
The Loop Calibrator’s display should read **V**.
2. Connect the test leads from the output **NORMAL** terminals of the Fluke 5500A to the input terminals on the Loop Calibrator (Black to **COM** and red to **[+]**).
3. Set the Fluke 5500A to test 7 in Table 4 and verify the display reading on the Loop Calibrator.

Repeat for tests 8 and 9.

The reading on the display should be within the minimum and maximum values shown in Table 4.

4. Set 5500A output to 0 V (zero), and set output to **STANDBY**.
5. Turn the rotary switch of the Loop Calibrator to **OFF** and disconnect the Loop Calibrator from the 5500A.

The performance verification tests are now complete.

If the Loop Calibrator failed any of these tests, calibration adjustment or repair is required.



Calibration Adjustment Procedure

Perform the following calibration adjustment procedures if the Loop Calibrator fails the performance verification test.

Notes

Make sure that the Loop Calibrator has a new battery before starting the calibration procedure. Calibration will not function properly if low battery indicator  is on.

Because the Fluke 705 Loop Calibrator incorporates several key hold start up features, entering the CAL mode through the keypad requires an exact key hold sequence.

1. With the rotary switch in the **OFF** position, hold down the  key and turn the rotary switch to **V MEASURE**.
2. When **CAL** appears, press and hold the  and the  keys. Immediately release both keys when **CAL** disappears. Verify that the display shows **MEASURE 0.000V** with no – sign or fluctuating digits. If it does not, CAL mode has not been successfully entered.
3. Connect the test leads from the output **NORMAL** terminals of the Fluke 5500A to the terminals on the Loop Calibrator (Black to **COM** and red to **[+]**).

4. Set the 5500A output to 0 V dc and select **[OPR]**.
5. Press any key until the Loop Calibrator's display changes.
6. When the display shows **28.000 V**, set the 5500A output to 28 V dc.
7. Press any key until the Loop Calibrator's display changes.
8. When the display shows **HHHH**, place the 5500A in the **STANDBY** mode.
9. Press any key until the Loop Calibrator's display changes.
10. Turn the Loop Calibrator's rotary switch to mA.
11. Press any key until the Loop Calibrator's display changes.
12. Connect the test leads from the **AUX** terminals of the Fluke 5500A to the terminals on the Loop Calibrator (black to **COM** and red to **[+]**).
13. Set the 5500A output to 0 mA dc and select **[OPR]**.
14. Press any key until the Loop Calibrator's display changes.
15. When the display shows **20.000 mA**, set the 5500A output to 20.000 mA.

16. Press any key until the Loop Calibrator's display changes.
17. When the display shows **HHHH**, place the 5500A in the **STANDBY** mode and remove any test lead connections to the Loop Calibrator.
18. Short the terminals and press any key. The Loop Calibrator now enters a self-source calibration adjustment process. The output must be shorted during this step.

The Loop Calibrator resets power when the self-source calibration adjustment is complete.

Note

The Loop Calibrator resets to the current source function prior to entering the self-source calibration procedure, i.e., 0.000 mA for 0-20 mA loop or 4.000 mA for 4-20 mA loop.

19. Remove all connections and place the rotary switch of the Loop Calibrator to **OFF**.

The calibration procedure is now complete.

User-Replaceable Parts

User-replaceable parts, are listed in Table 5 and shown in in Figure 3.

Table 5. User-Replaceable Parts

Item Description	Part No.	Quantity
Lens	665114	1
Case top	665098	1
LCD	665122	1
Elastomeric strip (LCD to PCA)	867247	1
Elastomeric strip	867242	1
Keypad assembly	665117	1
Actuator switch	203445	1
Switch support assembly	879031	1
Case bottom	665109	1
Screws, phillips-head	832246	4
Foot, non-skid (rubber)	885884	1
Battery, 9V ANSI/NEDA 1604A or IEC6LR61	696534	1
Battery door	665106	1
Main PCA	800893	1